

PLW

PV Solar Hot Water Controller

Manual

Read this before installing

Rev. U3. 27112017

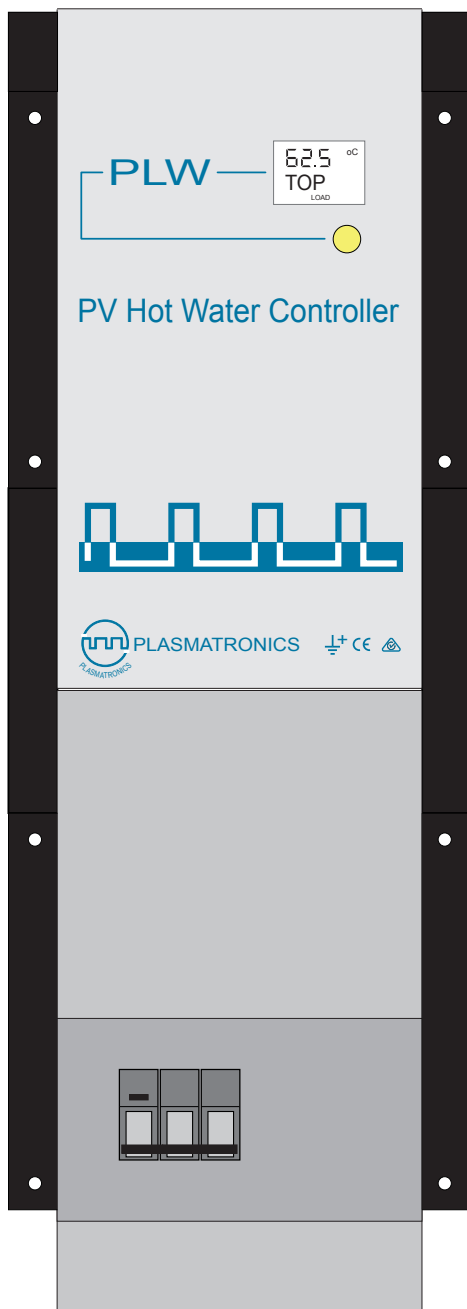

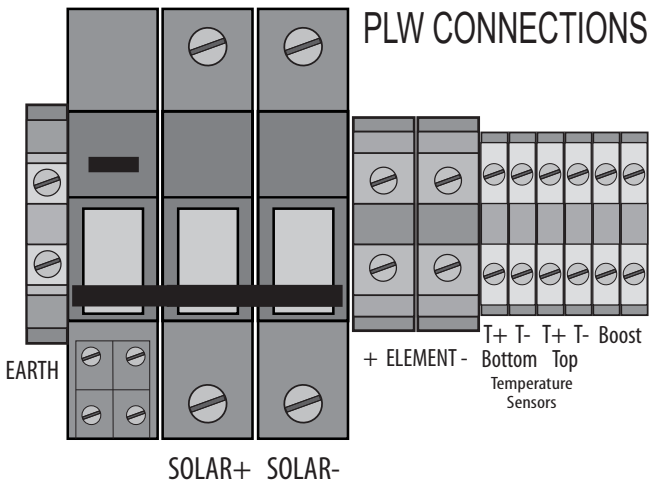
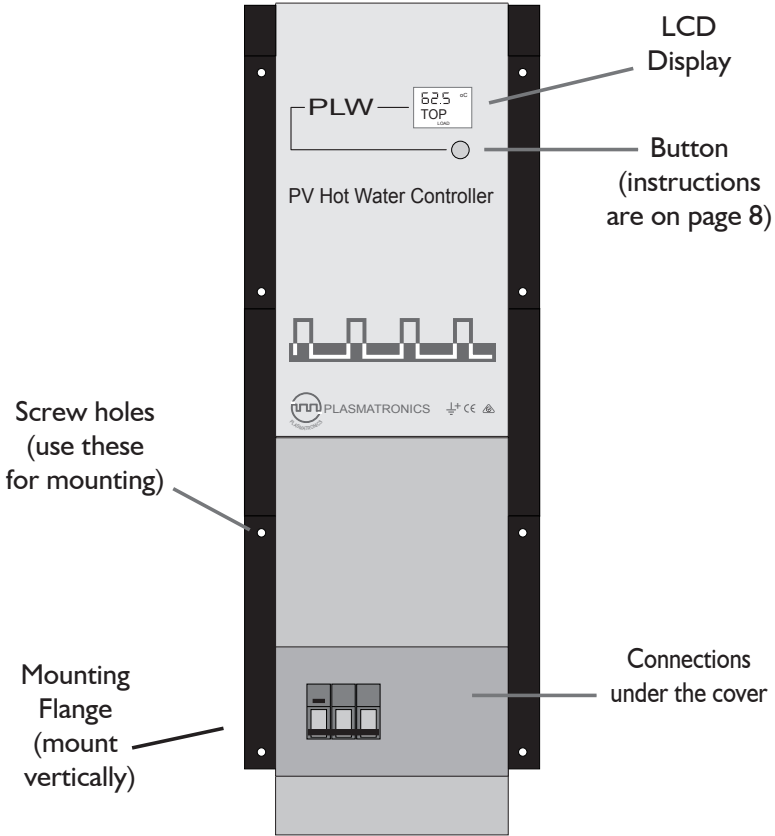

The PLW is a photovoltaic solar hot water controller.

It takes DC current from a nominal 48V Photovoltaic Solar Array and supplies DC current to a custom water heating element. The element must be mounted in a suitable tank. For direct connection a low-pressure hot water tank must be used. The tank must be open to the atmosphere and not a pressure vessel. If a mechanical thermostat with a safety cutout is also installed on the tank then a mains pressure tank can be used.

The PLW takes information from two temperature sensors and displays it

to the user. This information is also used to control the maximum tank temperature (thermostat function). The resulting system does not need boosting from other energy sources if an adequately sized PV Array is installed (see guide page 13). Boosting may be provided from an independent heat source e.g. a wood stove. Boosting with mains/grid electricity is not possible with the low voltage element supplied, Tanks with two elements can run one on PV solar and the other on the mains/grid. For both elements to run on solar it is necessary to use two PLW units (see page 13)

Contents

Location	4
Wiring Instructions	4
Installing the element	6
Installing the temperature sensors	6
Using the Menus	8
Choosing your settings	9
How it works	10
Monitoring your system	10
Array sizing	13
Sharing the array	13
Tanks with two elements	13
Specifications	15

Selecting a Location

Locate your PLW:

- Vertically, where air can circulate around it
- In a dry environment out of direct sunlight
- Away from flammable gasses or liquids
- Away from spiders or insects

Warning: This controller is for DC current only.

The maximum load (i.e. element) current rating is limited to 30A. The PLW requires the use of a custom water-heating element sized for use with a nominal 48V array. For other voltages contact Plasmatronics.

The PLW can be placed near the tank or where it is convenient for the user.

There are two small screws in the sides of the wiring cover. These screws are essential for transport. Transporting the unit without these screws in place will result in damage to the unit and void the warranty. Keep the screws!

Wiring Instructions

Wires should be connected tightly as follows:

- Ensure Solar circuit breaker is turned off (down)
- Connect the system earth to the earth terminal provided. **Do not earth the array connections.**
- Connect the tank earth to the earth terminal provided. .
- Connect the load (element) positive to the load positive terminal.
- Connect the load (element) negative to the load negative terminal provided.
- Connect both temperature sensors paying particular attention to polarity. Refer to page 7 for instructions. Make sure the sensor labelled Bottom is installed in the bottom of the tank and is connected to the PLW terminals labelled bottom.
- Connect the Solar Array positive to the Solar Positive Circuit Breaker provided.
- Connect the Solar Array negative to the Solar Negative Circuit Breaker provided.
- Do not turn the circuit breaker on until the wiring cover is in place and all remote terminations are made safe.

WARNING

Never connect anything to the load terminals except the element provided. If you wish to use any other device, please contact Plasmatronics

Caution!

The PLW has a monitoring circuit which can detect certain faults in the PLW operation. If a fault is detected, the circuit breaker will turn off to ensure safety.

If you find the breaker has turned off by itself, then there is probably a fault in the PLW and the source of the fault needs to be found and fixed before operation can continue.

PLW HOT WATER SYSTEM DIAGRAM (single element)

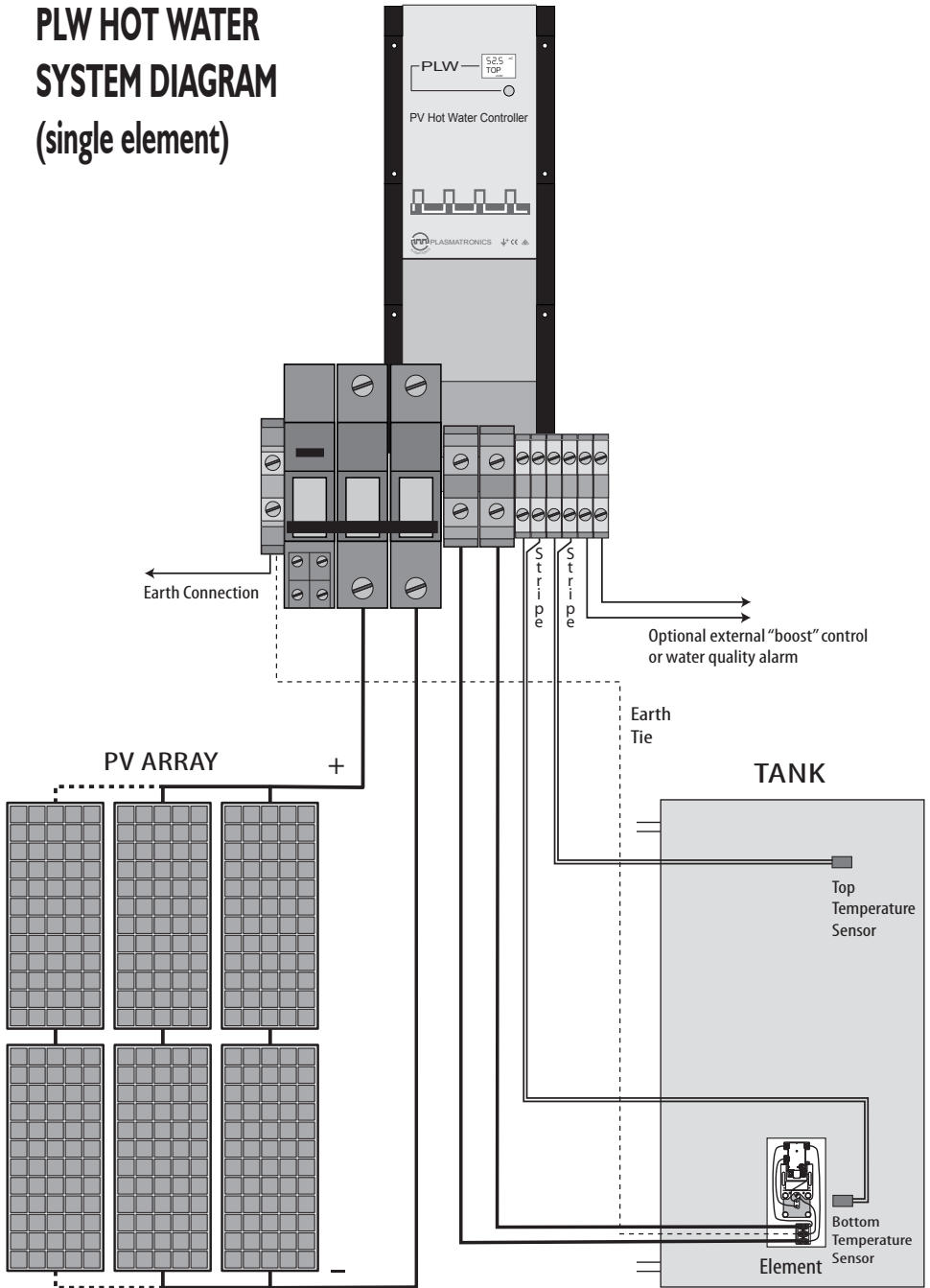

Installing the element

- Isolate any existing electricity supply
- Turn off the water supply and drain all the water from the tank
- Remove connection area cover from the tank
- Disconnect the existing element from its electrical terminals

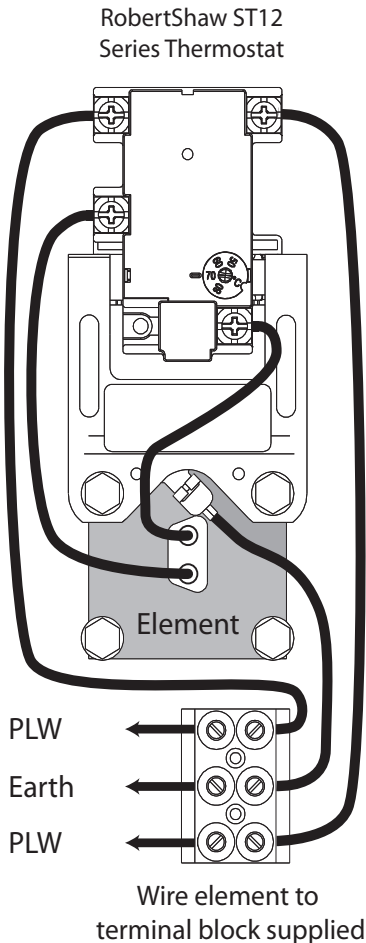

Example Element Connection

- Remove the four bolts retaining the existing element
- Ease the existing element from the tank. Take note of the orientation of the curve of the element within the tank
- Fit new rubber seal to the new element
- Fit the new element (and the thermostat). If possible use the same orientation of the curve within the tank as the old element
- Fit the four bolts and tighten progressively to a firm tension with hand tools. Too loose will leak, too tight will damage the rubber seal
- Fill the tank with water and check for leaks around the element seal
- Mount the terminal block supplied within the enclosure. It is usually possible to mount it in place of the original electrical terminal
- Connect from the terminal block to the thermostat input terminals using the new wires provided. Connect the new element to the thermostat element terminals. (see example diagram).
- Wire from the PLW Element terminals to the terminal block.
- Adjust the thermostat setting - see pg10

Installing the temperature sensors

- It is essential to install the bottom temperature sensor. The top sensor is optional (but very useful)
- Locate the bottom sensor slightly higher up the tank than the element. Ideally at the same height on the tank as the existing thermostat. It is acceptable but not essential to locate the sensor within the connection area

- c. Using a large screwdriver or similar tool, create a horizontal gap between the metal of the tank and the insulation. The gap should be slightly smaller than the temperature sensor.
- d. Push the sensor into the gap so that it is held against the metal of the tank.
- e. Locate the top sensor near the top of the tank but lower than the hot water outlet. The reading from the top sensor tells the user a lot about the system. All the water above the sensor height has the same temperature as the sensor or more. It is usually helpful to mount the sensor far enough below the outlet that it represents a useful amount of hot water, for example 1 or 2 typical showers. We suggest at least 150mm. The sensor for the bottom is labelled 'BOTTOM' and the top sensor is labelled 'TOP'.
- f. There is often no convenient opening in the tank outer skin at the desired sensor height, so it is necessary to create one. Be very careful not to damage the metal of the tank!
- g. Using a large screwdriver or similar tool, create a horizontal gap between the metal of the tank and the insulation. The gap should be slightly smaller than the temperature sensor.
- h. Push the sensor into the gap so that it is held against the metal of the tank.
- i. If necessary, the hole can be back filled with a piece of polystyrene foam or spray foam. Be careful not to get any between the sensor and the metal of the tank.
- j. Terminate both sensors to the appropriate connectors in the PLW. Be careful to connect the bottom sensor to the terminals labelled Bottom and the top sensor to the terminals labelled Top. If they are connected to the wrong terminals, the displayed information will be wrong and the thermostat function will not work properly. Correct polarity of each sensor is also essential. The black stripe on the temperature sensor lead goes to the **negative** side.

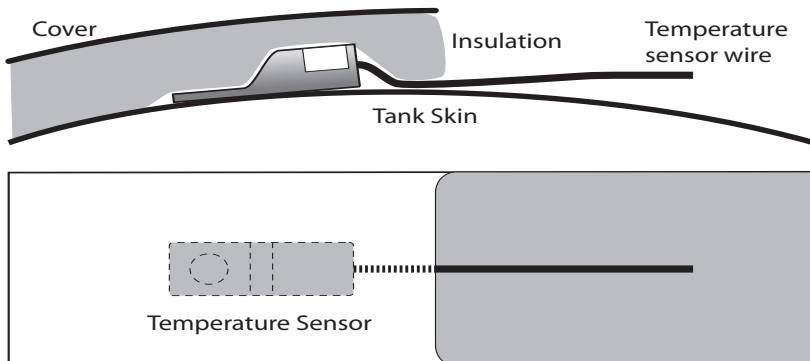

Temperature Sensor Installation

Using the Menus

Moving around

You can move around the menu system and change settings using the button on the front of the PLW.

There are 6 top level menu items in the PLW menu (TOP, BOT, WATT etc - see diagram below). Some menu items provide access to a sub-menu, and some of these sub-menus lead to further sub-menus.

A **short-push** advances the PLW to the next menu or setting. To do a short push, press on the button on the front of the PLW, and release it immediately.

A **long push** “selects”, to move into a sub-menu or to allow you to change settings. To do a long push, press the button, holding it down until the menu changes (about one second).

Getting back

Wherever you are in the menu system, a series of short-pushes will bring you back to the top-level menus without changing any settings. There are two exceptions: when a number is flashing (you are already changing a setting); and when you see the word “EXIT” (you’re in “History” mode - see page 12).

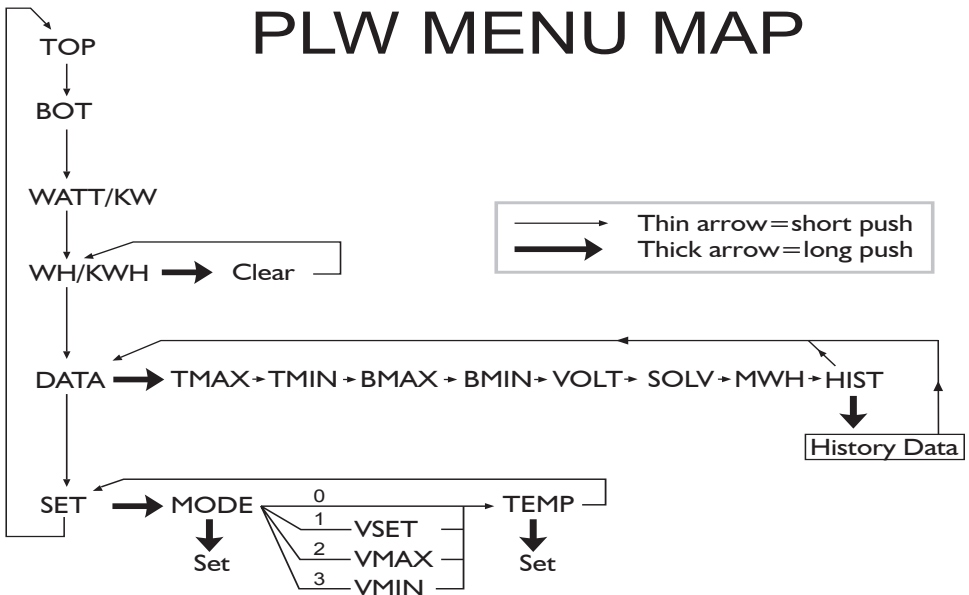

Choosing your settings

If you are using only one PLW, not sharing the array with any other system and you are happy with the default thermostat setting of 70 °C, there is no need to make any settings changes. The default settings are already the best you can have. You can skip this section.

Note: the settings are not lost if the power to the PLW is disconnected.

1. Set the MODE

The PLW has three operational modes (see below). To set the mode:

- Short-push until the display shows "SET".
- Long-push once, the display will show MODE and a mode number
- Long-push once, the number will start flashing.
- Short-push until the number is right for the mode you want.
- When the mode number is correct, long-push once to set it.

MODE 1

The default is MODE=1. The PLW adjusts the loading on the array to maximise the amount of energy going into heating the water. This style of operation is commonly referred to as MPPT (Maximum Power Point Tracking).

MODE 2

The PLW operates the array at a fixed voltage. The voltage must also be set. This is useful if sharing the array (see page ref)

MODE 3

The PLW operates in MPPT mode like MODE1 except that there is a maximum array voltage. The maximum voltage must also be set.

MODE 4

The PLW operates in MPPT mode like MODE1 except that there is a minimum array voltage. The minimum voltage must also be set.

Now short-push once to move to the next setting

2. Set the Voltage.

If you select MODE=1 you do not need to set a voltage. For MODE= 2,3 or 4 there is now a voltage to set on the display.

- Long-push once, the voltage will start flashing.
- Short-push until the voltage shows the desired value.
- When the value is correct long-push once to set it.
- Short-push once to move to the thermostat setting

3. Set the thermostat temperature (TEMP)

- Long-push once, the temperature will flash
- Short-push until the temperature shows the desired value
- When the value is correct, long-push once to set it
- You have set all the settings. Do a short push to return to the main menu.

Note: It is tempting to set the maximum temperature that the tank is rated for as this gives the maximum energy storage. But, be aware that many tanks will last longer at lower temperatures. Also if the array will be used for another task after the water is hot,

setting a lower temperature will mean that it becomes available sooner. Enamelled steel tanks should not be used at temperatures over 70°C. If you are not sure, do not set the thermostat higher than 70°C.

The mechanical thermostat on the tank **MUST be set higher** than the PLW setting.

How it works

The PLW heats the water in your tank with electrical energy from the solar array. The DC current from the array powers the PLW and charges a capacitor. The PLW uses Pulse Width Modulation (PWM) to supply exactly the right amount of current to the element to keep the capacitor at a target voltage. The target voltage may be set automatically in mode 1, set on installation in mode 2, or a combination of the two in mode 3 and mode 4. This arrangement means that the element voltage is often lower than the array voltage. The PLW is only powered when the array is in sunlight so it does nothing at night-time and no data or settings are available at night. The PLW turns on in the morning when the array voltage reaches 26V and turns off in the evening when the array voltage falls below 13V.

Monitoring your system

Your PLW gives you a lot of information about your hot water system. Here are some of the questions your PLW can answer:

How warm is the water?

The TOP and BOT screens give you accurate real time information about the water temperature in the tank.

Is there enough warm water for a shower?

The TOP reading tells you that all the water above the sensor is at the same temperature as the sensor or warmer. If the TOP sensor is mounted a suitable distance below the tank outlet, the TOP reading tells you how warm that much of the water is. Most people find 42°C is adequate for showering.

How well is the solar array performing?

The Watt/KW screen shows the real time array power. The SOLV screen in the DATA sub-menu shows the array open circuit voltage.

How much energy has been collected today?

The Wh/KWh screen shows the energy collected today.

How hot did the water get today?

The TMAX and BMAX screens show the maximum temperature for the TOP and BOT sensors so far today. TMAX and BMAX are found in the DATA sub-menu

How cold did the water get today?

The TMIN and BMIN screens show the minimum temperature for the TOP and BOT sensors so far today. TMIN and BMIN are also found in the DATA sub-menu

The LCD Screen

Extra system information is given by words that appear along the bottom of the LCD screen.

BOOST:

The PLW has detected that auxiliary energy is required. This occurs when the water temperature, and time at that temperature, do not meet the requirements for safe hot water. The PLW also activates the “boost” output when BOOST is displayed, enabling automatic boosting schemes to be used or warns the user that manual intervention is required or that the water should not be used.

LOAD:

The PLW is delivering power to the element. LOAD will not be visible when there is no power being delivered, usually because the thermostat temperature has been reached.

Summary of menu items

TOP	Temperature of top sensor
BOT	Temperature of bottom sensor
Watt/kW	Element power in real time
VOLT	Operating voltage of the array in real time
SOLV	Array open circuit voltage. (When in this screen, heating is suspended)

These parameters are only available in real time, i.e. they are not stored to history

TMAX	Maximum temperature of the top sensor today
TMIN	Minimum temperature of the top sensor today
BMAX	Maximum temperature of the bottom sensor today
BMIN	Minimum temperature of the bottom sensor today
WH/KWH	Energy collected today
MWH	Energy collected in the life time of the PLW

At the end of each day, these parameters are stored in the history.

DATA	Sub-menu heading
SET	Sub-menu heading
MODE	Setting
VSET/VMAX/VMIN	Voltage setting required by the Mode setting (in the SET sub-menu)
TEMP	Setting for thermostat function temperature

Retrieving historical data

In addition to storing today's performance data, the PLW keeps information about the last 30 days of operation.

Historical performance information can be accessed from the DATA sub-menu (see diagram below). After a long-push on DATA, short-push until you see HIST. A

long-push on HIST will put you in "history mode", where you can cycle through each day's data. (Note the day numbers go backwards- i.e. DAY 1 means yesterday, and DAY 30 is 30 days ago.)

The history parameters are stored when the sun goes down.

PLW History Menu

→ Thin arrow = short push
 ⇨ Thick arrow = long push

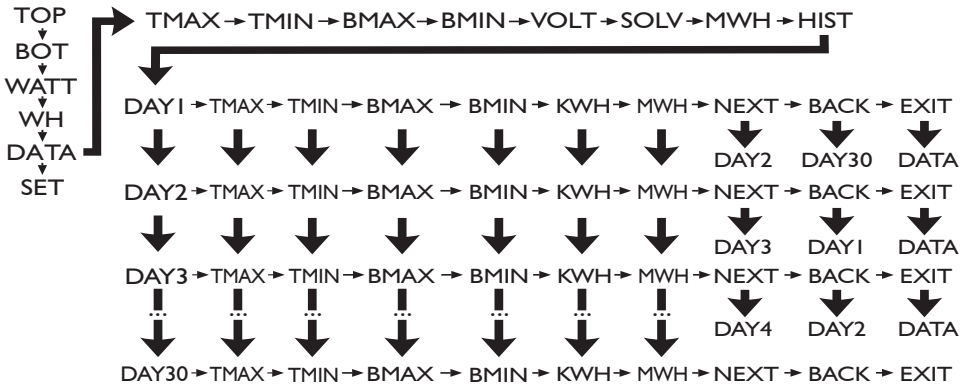

Water quality safety.

Care must be taken with any hot water system to avoid a build up of Legionella. Hot water is considered safe if it has been heated to a specific temperature for a specific length of time.

This is important for limited energy systems like the PLW in poor weather conditions where the system may be struggling to get the water hot enough.

The PLW monitors the water temperature and times. If the conditions for Legionnaires prevention are not met, then it turns on the 'boost' alarm. (BOOST appears in the display). It also closes the relay contacts on

the 'boost' output. The boost output can be used to activate an alarm or turn off a solenoid in the water line. Since the PLW turns off at night, the boost signal disappears overnight (but its state is remembered and restored in the morning). The boost alarm must either be responded to during the day or enable a latching alarm which must be manually reset.

If the alarm comes on, supply external energy by lighting the stove or running a generator. Otherwise, wait until the alarm clears before using any hot water.

Array sizing

The PLW should be used with a 2.5 ohm element. This is optimised for operation with a 48V array made up of series pairs of panels where each panel has 60 cells.

With this array, up to 80A of array current capability can be installed. *The element will limit the delivered array current to 30A.* The maximum power the element can draw is about 2kW (at NOCT). But, the larger the array, the more energy it will be able to deliver during periods of low solar input. This is deliberate over powering for winter conditions.

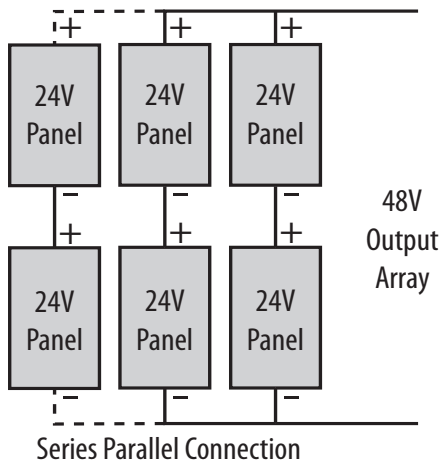

An array of 72 cell panels can also be used, but the total installed array current (I_{mp}) **must be less** than 30A (at 80V).

The 2.5 ohm element will operate with a 24V array, but it will deliver much less power to the water. With a 72 cell panel, the maximum power is only about 400W. Unless the 24V array produces less than 15A, you would be better off to rewire the array for 48V or use an element customised for 24V operation. Contact Plasmatronics for further information.

Sharing the array

It is possible to connect the PLW to an array that is also used to charge batteries. It does not matter what style or brand of charge controller is used to charge the batteries *so long as the array connections are not earthed.* A suitably rated diode with an appropriate heat sink must be fitted between the PLW and the array. Mode 2 or Mode 4 is recommended. Select a voltage equal to the expected Maximum Power Point Voltage (V_{mp}) of the array. When the batteries are charging and need all of the available charge current, the array voltage will be below the setting and the PLW will take no power. When the batteries are close to full and no longer need all the charge current, the array voltage will rise and the PLW will start taking some of the power. The PLW will take all the power that the batteries don't need until the water is hot and the PLW also turns off.

Tanks with two elements

If your hot water tank has two elements and you want to run both with PV you should use two PLW units, one dedicated to each element. The PLWs share a common array. The typical arrangement for two elements in one tank is one fitted to the bottom and one near the top. This arrangement is optimised so that the bottom element usually provides the bulk of the hot water and the top element is used when the hot water runs out so that a small amount can be heated up quickly. This is good for mains/grid connected systems using night rate electricity for the bottom element and expensive electricity only in the top element if necessary. The same arrangement also suits PV hot water quite

well. If only a small amount of solar energy is available, only the top of the tank is heated. If lots of energy is available, the whole tank is heated creating a reserve for future poor weather.

Setup for two element tanks

Use two PLW units and two elements. Wire each one to the tank independently as follows:

Top element PLW:

Set a lower thermostat setting than the other PLW. Typically 50-60°C
MODE=1

Bottom temperature sensor (of the Top PLW) mounted level with existing top thermostat

Top temperature sensor mounted approximately half way between the top thermostat and the hot water outlet

Bottom element PLW:

Higher thermostat setting than the other PLW. If unsure, use 70°C.

MODE=4

Set VMIN= Expected Maximum Power Point Voltage (Vmp) of the array

Bottom temperature sensor (of the bottom PLW) mounted level with existing bottom thermostat

Top temperature sensor mounted level with top thermostat or lower as desired

Both units can share the same array. If there are no other devices connected to the array, diodes are not required.

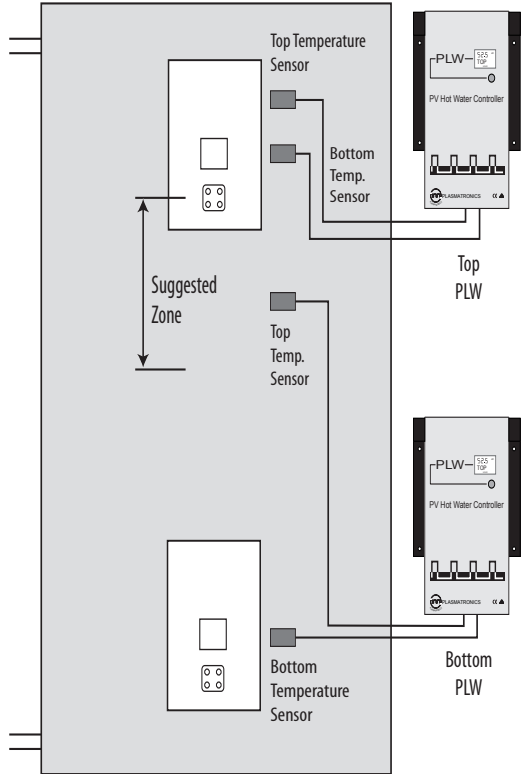

Two Element Connection

Alternatively, the upper element can be wired to an auxiliary energy source such as the mains/grid or a diesel generator. In this case only one PLW is fitted and it is connected to the bottom element. If a diesel generator fitted with remote start is used the auto start circuit may be wired to the BOOST output terminals enabling demand start when BOOST is active (see page 11).

Do not use any of the original thermostat wiring. Use the new wires supplied. Both elements must have their own safety thermostats (pg. 15) wired as per pg. 6.

Safety Thermostats

When used on pressurised tanks, there must be a safety thermostat installed to prevent the tank from boiling.

This safety thermostat is wired in series with the tank element. This thermostat is usually a mechanical device which does not reset after it operates.

The PLW uses its own temperature sensors to provide the normal thermostat function. If the PLW should fail for some reason, then the mechanical thermostat acts as a backup. If the mechanical thermostat does operate for any reason, then there is a fault in the system which must be fixed before using the PLW again.

The mechanical thermostat should also be replaced because there may have been some damage to its contacts. The PLW contains special circuitry to extinguish any arc that may form when the thermostat contacts open.

Some thermostats have an adjustable mechanical thermostat as well as a safety thermostat. As in the example on page 6, wire the mechanical thermostat in series with the safety thermostat and adjust the mechanical thermostat to its maximum setting. This will allow the PLW to do the thermostat function normally but give two levels of safety cutout in the event of a fault.

Specifications

Nominal Array Voltage	48	V
Maximum solar array Voc	100	V
Maximum average load (element) current	30	A
Maximum average solar current	30	A
Maximum voltage between the "Boost" relay terminals	85	V
Boost relay terminals maximum wire size	2.5	mm ²
Maximum "Boost" relay contact current	300	mA
Temperature sensor operating range	0 to 100	°C
Maximum ambient temperature without derating	50	°C
Maximum storage temperature	70	°C
Meter accuracy	< +/-2% FSD +2 dig	
Maximum wire size for Solar connection	35	mm ²
Minimum wire size for Solar connection	6	mm ²
Maximum wire size for Load connection	16	mm ²
Minimum wire size for Load connection	6	mm ²
Earth terminal maximum wire size	6	mm ²
IP Rating	IP20	

Safety

The PLW can have voltages within the case equal to the solar array open circuit voltage.

If the cover is to be removed while the PLW is connected to the solar array, first turn off the circuit breaker to disconnect the PLW from the solar array.

When the cover is removed, there is a red led indicator showing the voltage on the storage capacitor. Do not touch any of the wiring until the red indicator goes off. This can take up to 40 seconds.

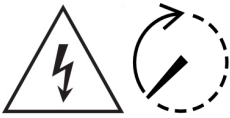

40 sec.

Shock hazard
Wait until red indicator turns off



Consult user manual
for cable sizing.

No user maintenance is required.
Solar array short circuit current must less than 80A.
In lightning prone areas, external lightning protection is advisable.

Plasmatronics Pty Ltd
ABN 98 073 758 497

<http://www.plasmatronics.com.au>

Rev. U3. 27112017